

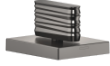



**CL.1 Deck valve clockwise closing cold - Brushed Dark Platinum**

CL.1

20 005 705

- with WAVES structure
- hole diameter 32 mm
- rosette 60 x 47 mm
- with cold marking



	Brushed Dark Platinum	20 005 705-99
	Chrome	20 005 705-00
	Brushed Platinum	20 005 705-06
	Dark Chrome	20 005 705-19
	Brushed Champagne (22kt Gold)	20 005 705-46
	Champagne (22kt Gold)	20 005 705-47

20 005 705

mm [inches]

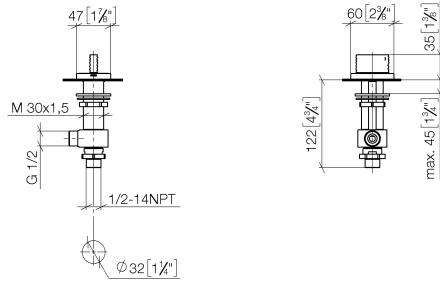

**Flow rate chart**



**Certificates**

WRAS\_1804020. IAPMO\_N-4976. LGA\_28687. IAPMO\_4976 (4). IAPMO\_6397.

WRAS\_240202020.

20 005 705

Parts for other finishes can be found here: [Chrome](#)

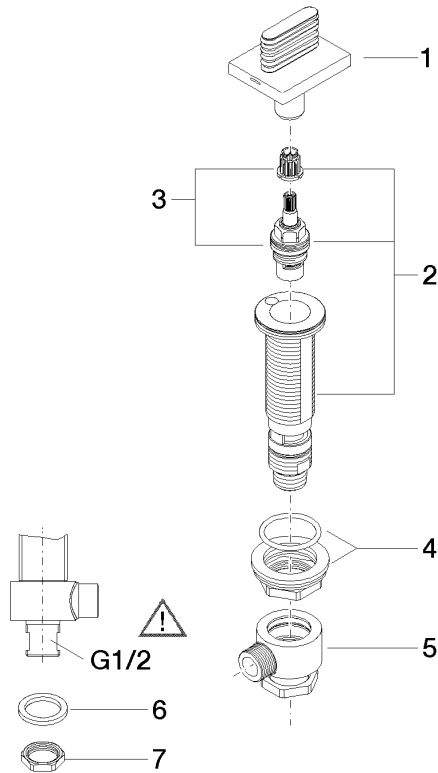

### Spare parts list

No.	Item Number	Name	Quantity used	Delivery time
1	90 20 70 055 06-99	handle ( cold )	1	30
2	04 17 11 058 53 90	side panel	1	2
3	90 90 03 153 00 90	top	1	2
4	04 23 10 032 78 90	fixing set	1	2
5	04 17 11 023 10 90	distributor	1	2
6	90 23 30 040 00-99	threaded connector	1	30
7	09 30 11 059 90	disc	1	2
8	09 23 10 012 90	nut	1	2